

Material:

Insulator: High Temperature Thermoplastic, UL 94V-0.

Contact: Copper Alloy T=0.15, Plated 50u" Ni Overall. Plated Au Selective Contact Area Plated 30u" - 70u" Sn Over Ni On Solder Area.

Shell: T=0.15, Plated 30u" Ni Overall min. Plated 0.5u" Au Selective Contact Area

Electrical:

Current Rating: 0.5 A

Voltage Rating: 3.3V

Ambient Temperature Range: -25°C ~ +85°C

Storage Temperature Range: -25°C ~ +85°C

Ambient Humidity Range: 95% R.H. Max.

Contact Resistance: 100mΩ Max.

Insulation Resistance: 1000MΩ Min./500VDC

Mating Cycles: 5000 Insertions.

Peak temperature: 260°C ±0.5°C

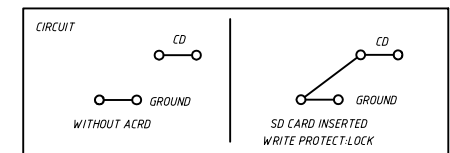
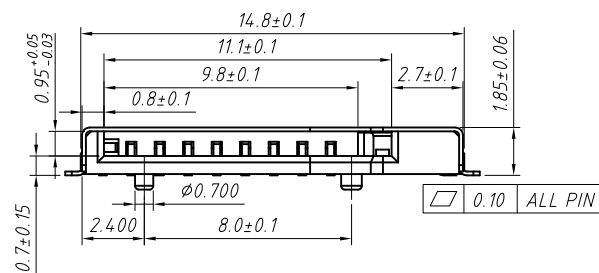

GENERAL TOLERANCE		ANGLE TOLERANCE		PROJECTION		Description:	
X	±0.15	X	±5°	UNITS	mm	Micro SD Card CONN; PUSH/ PUSH, H1.85mm, SMD with CD Pin L-KLS1-TF-003	
.X	±0.03	.X	±3°	SHEET SIZE	A4		
.XX	±0.05	.XX	±2°	KLS P/N:			
Draw by:	Jenny	Date:	2018-03-10	 NingBo KLS ELECTRONIC CO., L TD.			
Check by:		Date:	2018-03-10				
SCALE		SHEET	1	OF	1		

1 2 3 4 5 6 7 8

A B C D E F G H

T-Flash Card Insert Drawing:

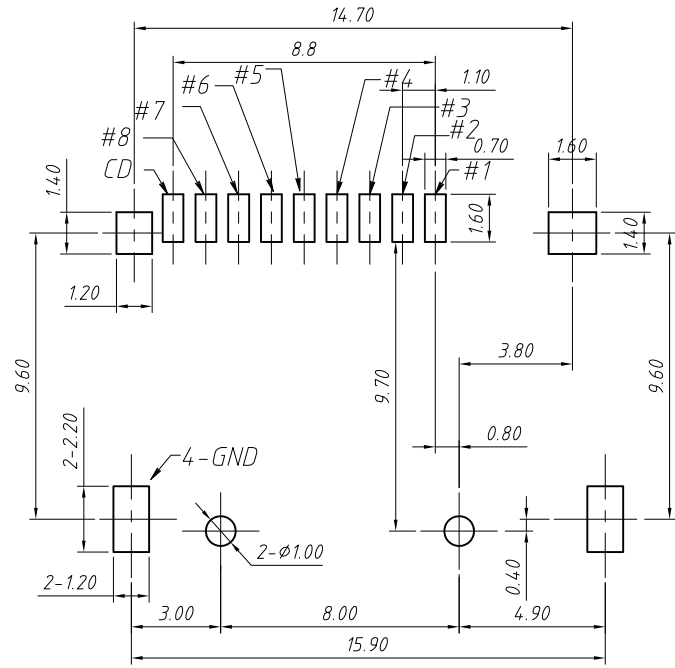

PIN NO.	PIN ASSIGNMENT
1 #	DAT2
2 #	CD/DAT3
3 #	CMD
4 #	VDD
5 #	CLK
6 #	VSS
7 #	DAT0
8 #	DAT1
9 #	CD

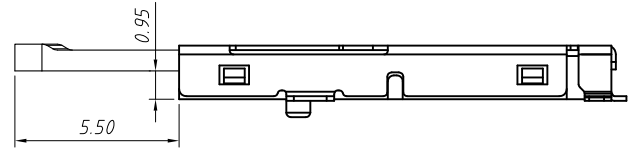

Micro SD Card-Un Lock

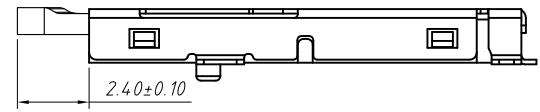

Micro SD Card-Lock

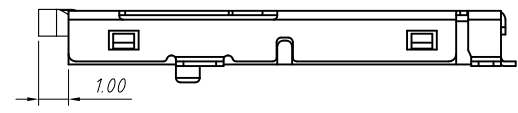

Micro SD Card-Push

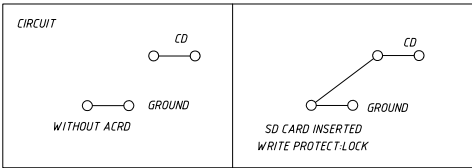
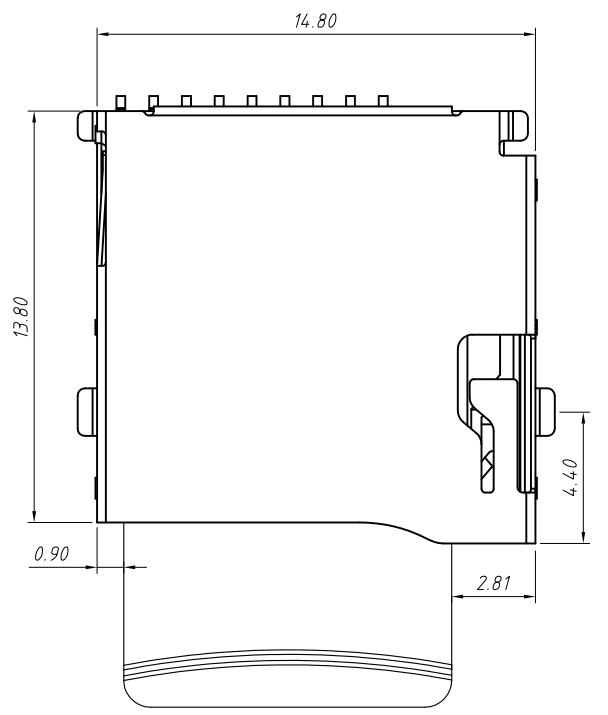

GENERAL TOLERANCE		ANGLE TOLERANCE		PROJECTION	Description:	
X.	±0.15	X.	±5°	UNITS	Micro SD Card CONN;PUSH/ PUSH,H1.85mm,SMD with CD Pin L-KLS1-TF-003	
.X	±0.03	.X	±3°	SHEET SIZE		A4
.XX	±0.05	.XX	±2°	KLS P/N:		
Draw by:	Jenny	Date:	2018-03-10	 NingBo KLS ELECTRONIC CO.,L TD.		
Check by:		Date:	2018-03-10			
SCALE		SHEET	1 OF 1			

1 2 3 4 5 6 7 8

H

H