

LQH5BPN4R7NT0#

“#” indicates a package specification code.

Size Code 5050 (2020) in mm (in inch), 2.2mm max. Thickness



< List of part numbers with package codes >
LQH5BPN4R7NT0K LQH5BPN4R7NT0L

Applications

Unsuitable Applications	Please be sure to read and comply with these "Precautions for use."
Specific Applications	Consumer equipment, Medical equipment [GHTF A/B/C] except for implant & surgery & auto injector, Industrial equipment except for transportation & facility & energy equipment Please refer to Our Website and specifications, etc. for information about the performance, functions, quality, management, and safety required for the above applications, and use Products after confirming the performance and reliability of the actual Product.
Recommended Applications	Consumer equipment

Appearance & Shape

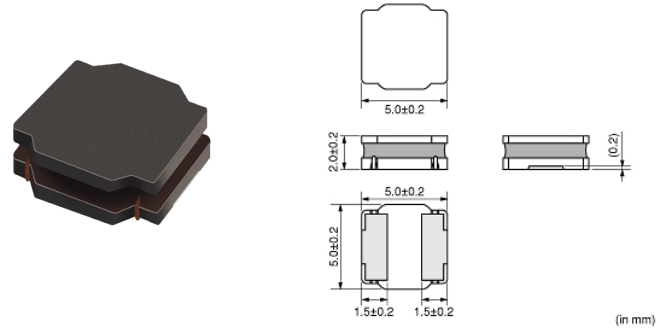

Notices

When rated current is applied to the products, inductance will be within $\pm 30\%$ of nominal inductance value. When rated current is applied to the products, temperature rise caused by self-generated heat shall be limited to 40°C max. Keep the temperature (ambient temperature plus self-generation of heat) under 125°C.

Attention
1. This datasheet is downloaded from the website of Murata Manufacturing Co., Ltd. Therefore, its specifications are subject to change or our products in it may be discontinued without advance notice. Please check with our sales representatives or product engineers before ordering.
2. This datasheet has only typical specifications because there is no space for detailed specifications.
Therefore, please review our product specifications or consult the approval sheet for product specifications before ordering.

LQH5BPN4R7NT0#

“#” indicates a package specification code.

References

Packaging	Specifications	Standard Packing Quantity
K	330Embossed Tape	3000
L	180Embossed Tape	500

Mass (typ.)	
1 piece	0.22g

Attention

- 1.This datasheet is downloaded from the website of Murata Manufacturing Co., Ltd. Therefore, it's specifications are subject to change or our products in it may be discontinued without advance notice. Please check with our sales representatives or product engineers before ordering.
- 2.This datasheet has only typical specifications because there is no space for detailed specifications.
Therefore, please review our product specifications or consult the approval sheet for product specifications before ordering.

LQH5BPN4R7NT0#

“#” indicates a package specification code.



Specifications

L size	5.0±0.2mm
W size	5.0±0.2mm
T size	2.0±0.2mm
Size code inch (mm)	2020 (5050)
Inductance	4.7μH±30%
Inductance Test Frequency	100kHz
Rated current (Isat) (Based on Inductance change)	3.0A
Rated current (Itemp) (Based on Temperature rise)	2.0A
Max. of DC resistance	0.0696Ω
Operating Temperature Range (Self-temperature rise is included)	-40°C to 125°C
Class of magnetic shield	Shielded (Magnetic Resin)
Self resonance frequency (min.)	40MHz
Operating Temperature Range (Self-temperature rise is not included)	-40°C to 85°C
Brand	Murata
DC Resistance Intermediate Values	0.058Ω±20%
Series	LQH5BPN_T0

Attention

- 1.This datasheet is downloaded from the website of Murata Manufacturing Co., Ltd. Therefore, it's specifications are subject to change or our products in it may be discontinued without advance notice. Please check with our sales representatives or product engineers before ordering.
- 2.This datasheet has only typical specifications because there is no space for detailed specifications.
Therefore, please review our product specifications or consult the approval sheet for product specifications before ordering.

LQH5BPN4R7NT0#

"#" indicates a package specification code.



Characteristic Data

The charts below may show another part number which shares its characteristics.

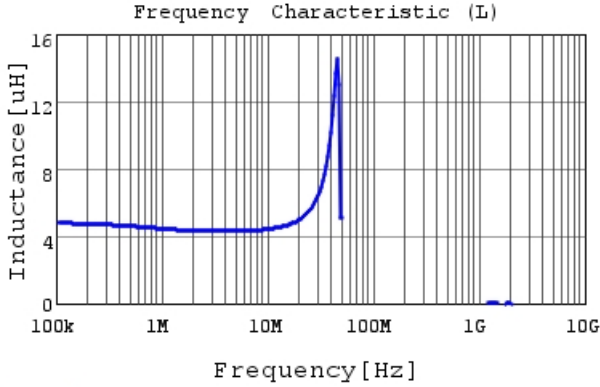

LQH5BPN4R7NT0 L

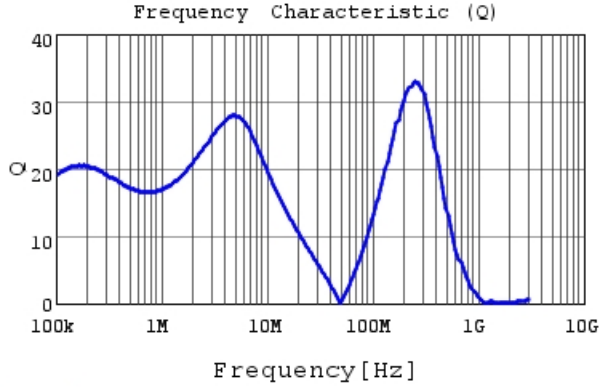

LQH5BPN4R7NT0 Q

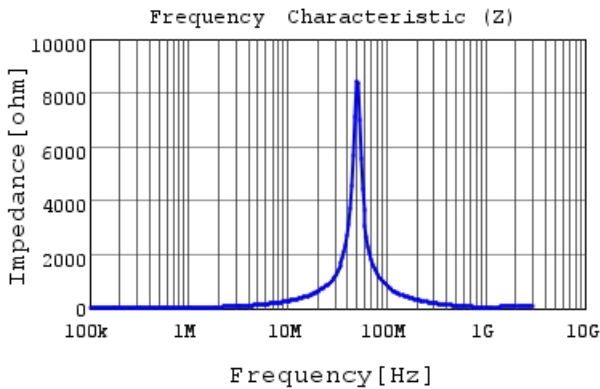

LQH5BPN4R7NT0 |Z|

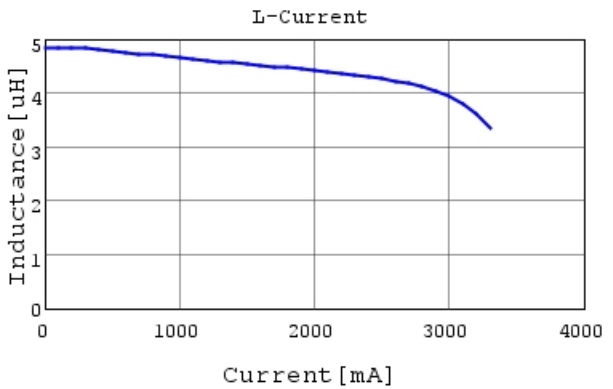

LQH5BPN4R7NT0 L-Current 20degC

Attention

- 1.This datasheet is downloaded from the website of Murata Manufacturing Co., Ltd. Therefore, it's specifications are subject to change or our products in it may be discontinued without advance notice. Please check with our sales representatives or product engineers before ordering.
- 2.This datasheet has only typical specifications because there is no space for detailed specifications.
Therefore, please review our product specifications or consult the approval sheet for product specifications before ordering.

LQH5BPN4R7NT0#

“#” indicates a package specification code.

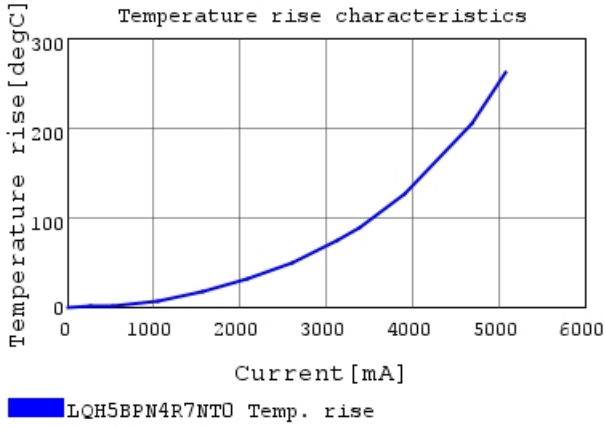

Attention

- 1.This datasheet is downloaded from the website of Murata Manufacturing Co., Ltd. Therefore, it's specifications are subject to change or our products in it may be discontinued without advance notice. Please check with our sales representatives or product engineers before ordering.
- 2.This datasheet has only typical specifications because there is no space for detailed specifications.
Therefore, please review our product specifications or consult the approval sheet for product specifications before ordering.